

Sieb

belichten

eine Anleitung in Bildern

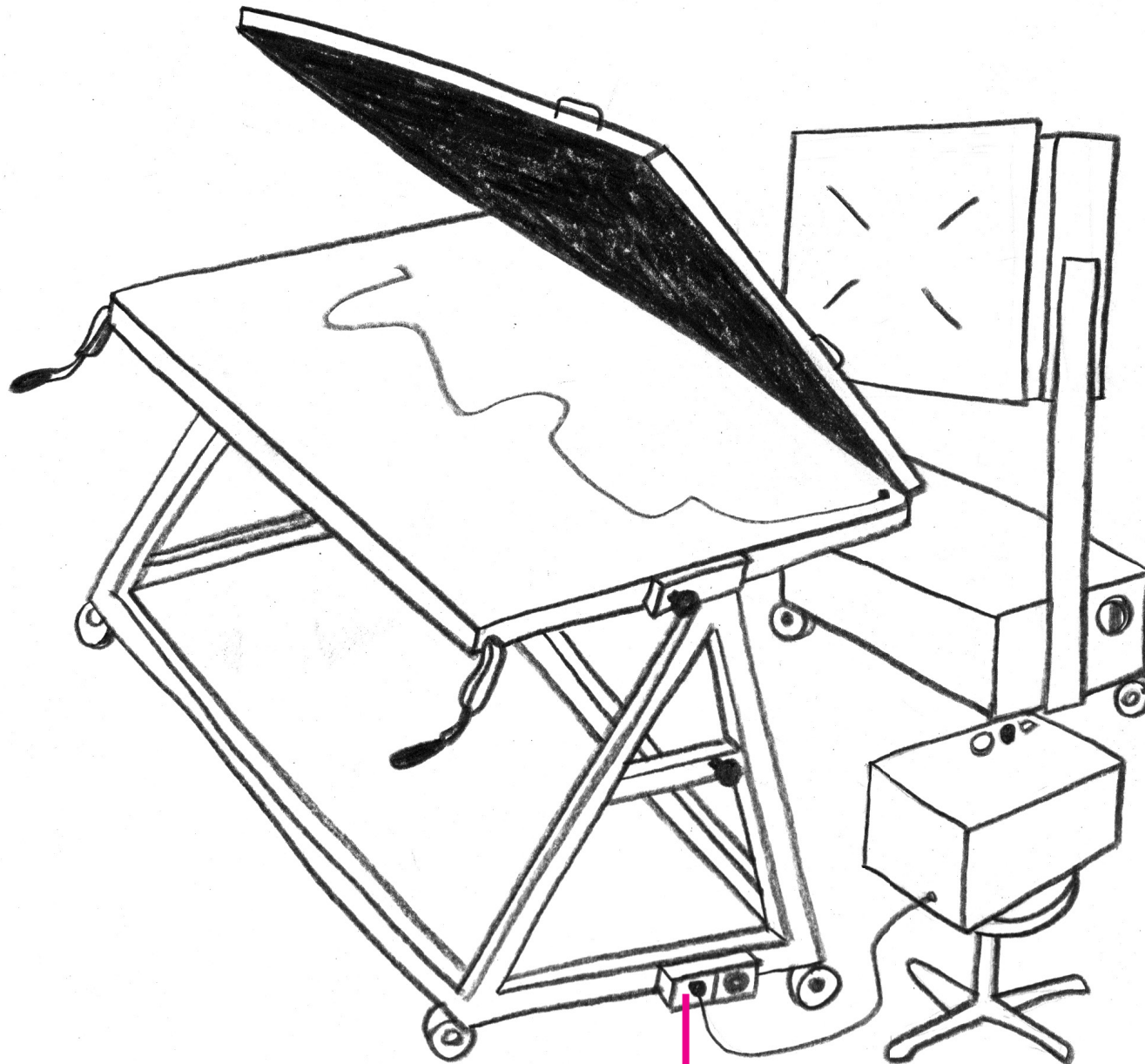

- Raum 070
- 1.) Gelblicht einschalten
 - 2.) Belichtungslampe einschalten

1.)

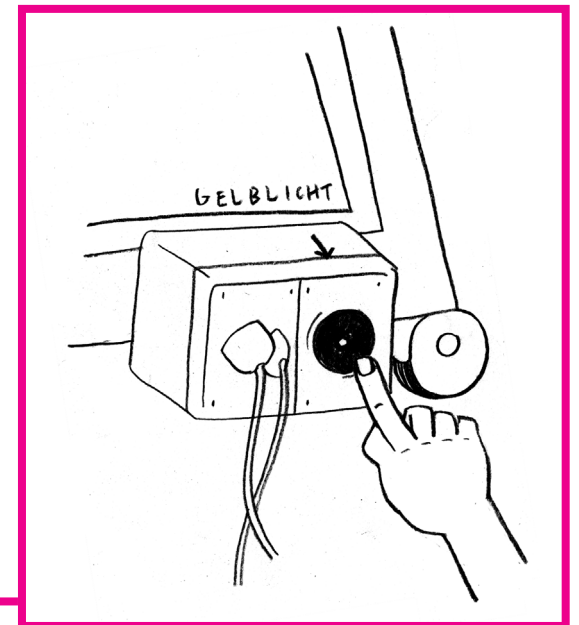

2.)

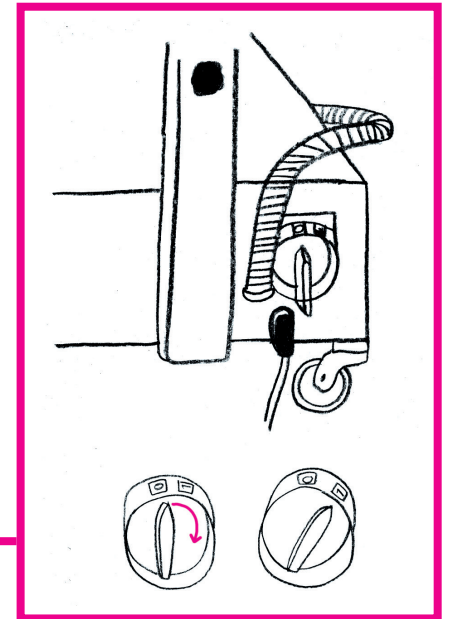

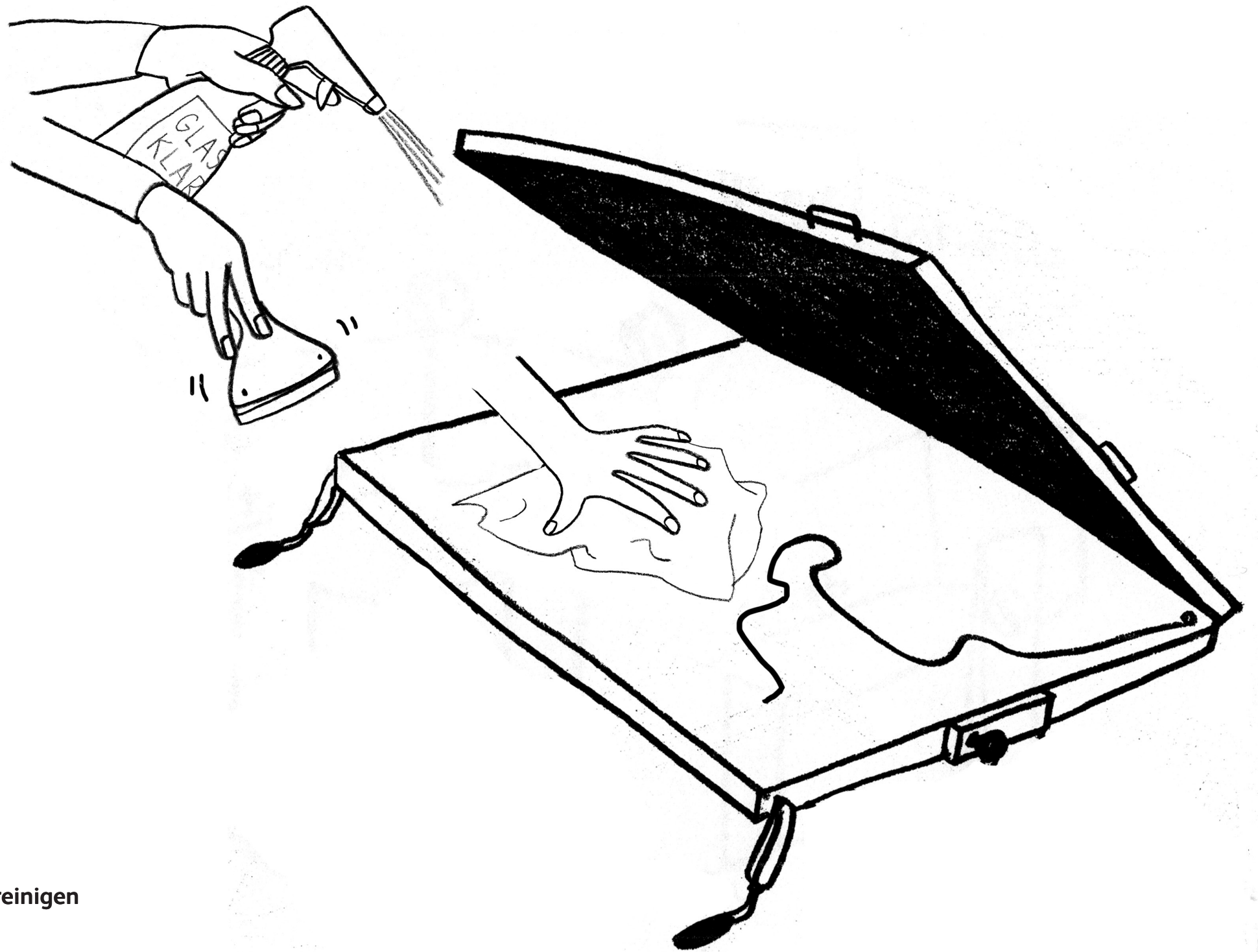

Glasplatte reinigen



Film (seitenrichtig)
auf die Glasplatte legen

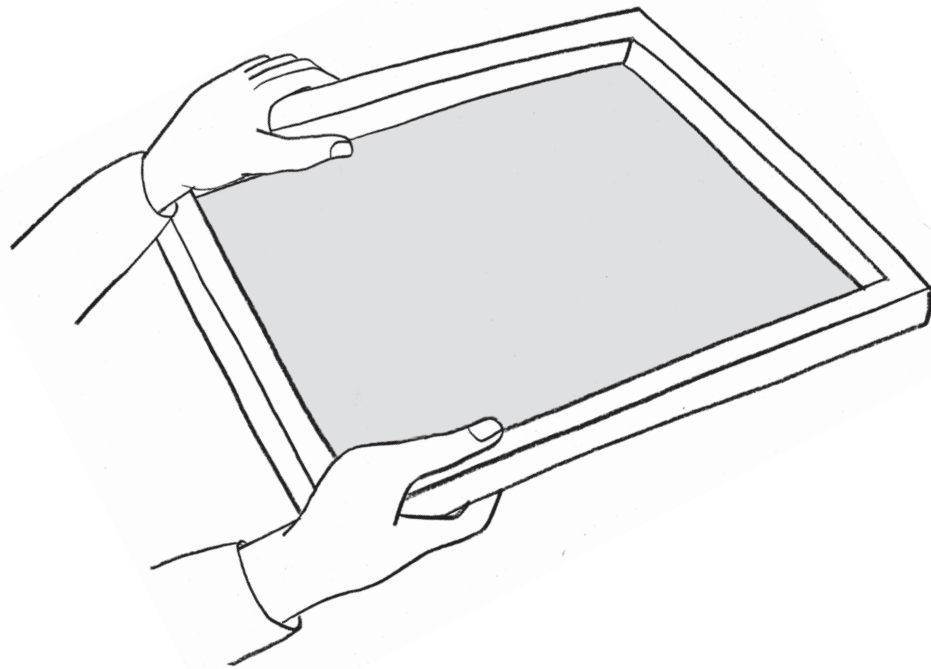

beschichtetes Sieb auf
den Film legen

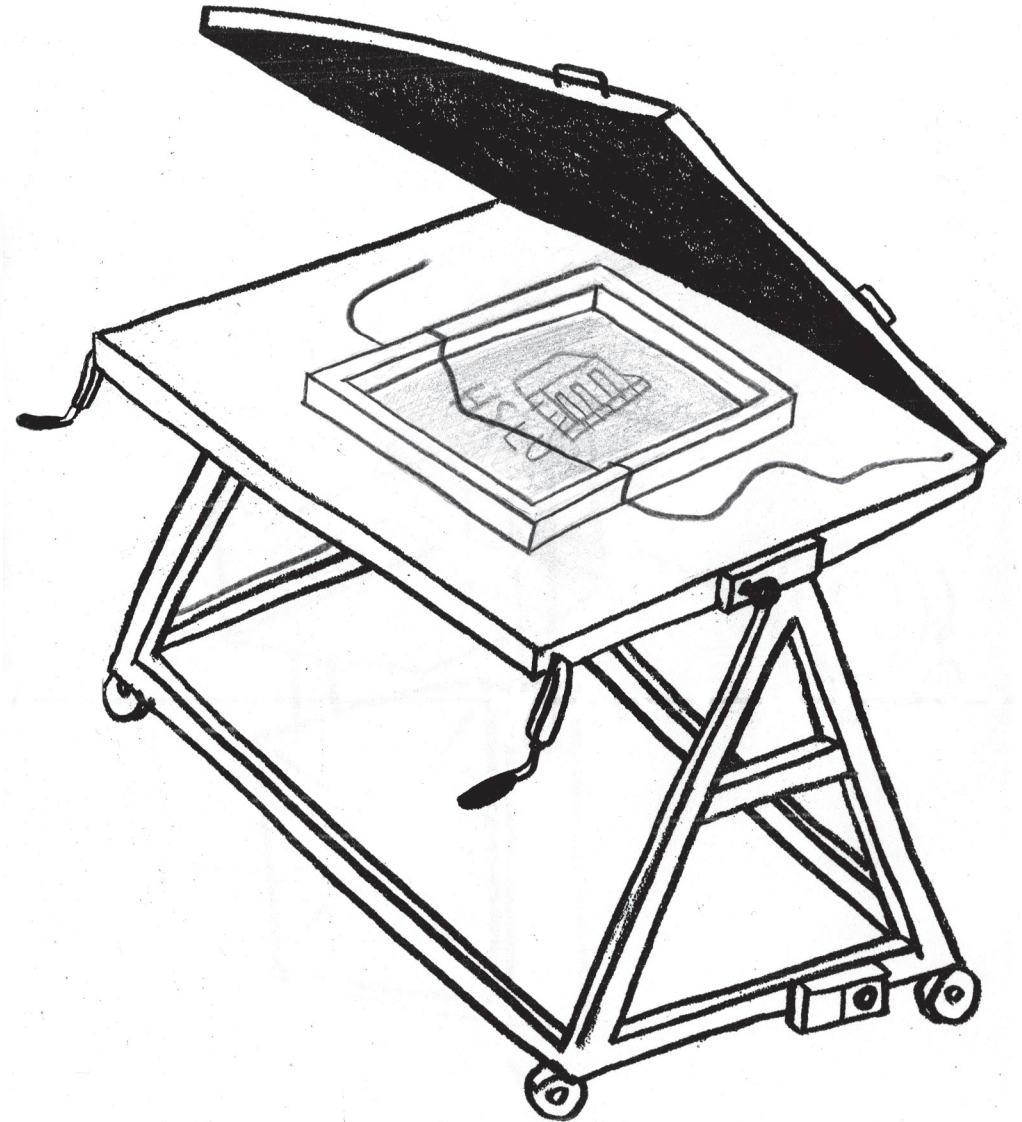
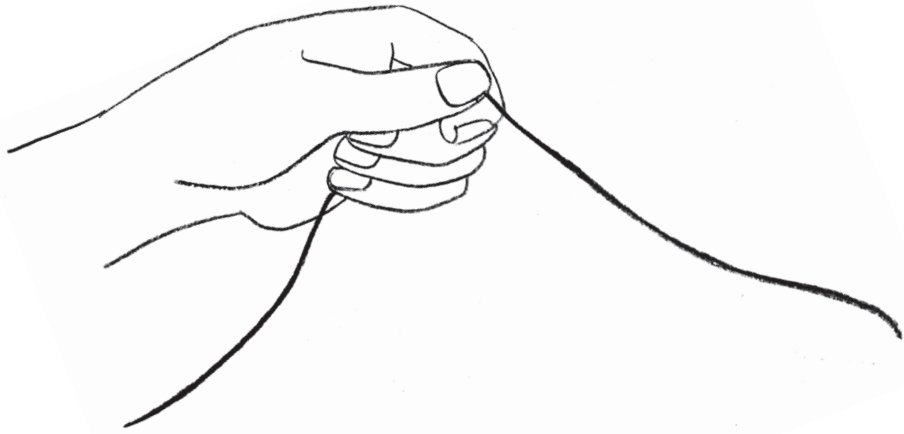

Metallschnur quer über die Glasplatte
und über das Sieb legen



Tisch schliessen

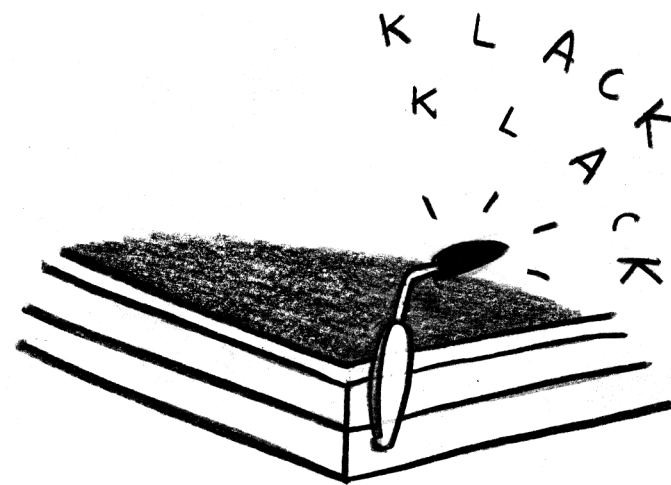
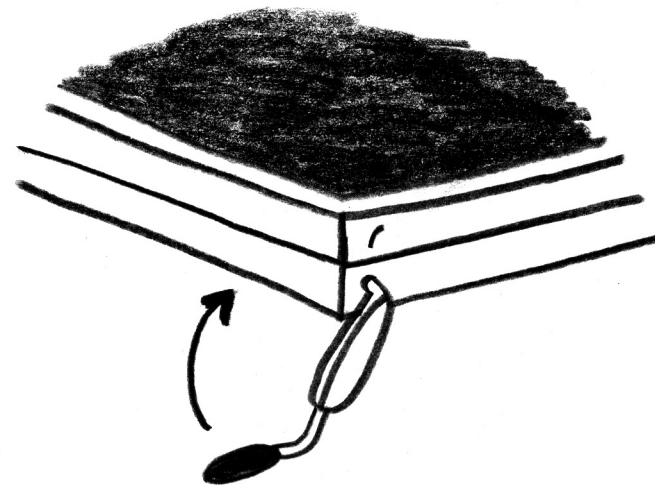

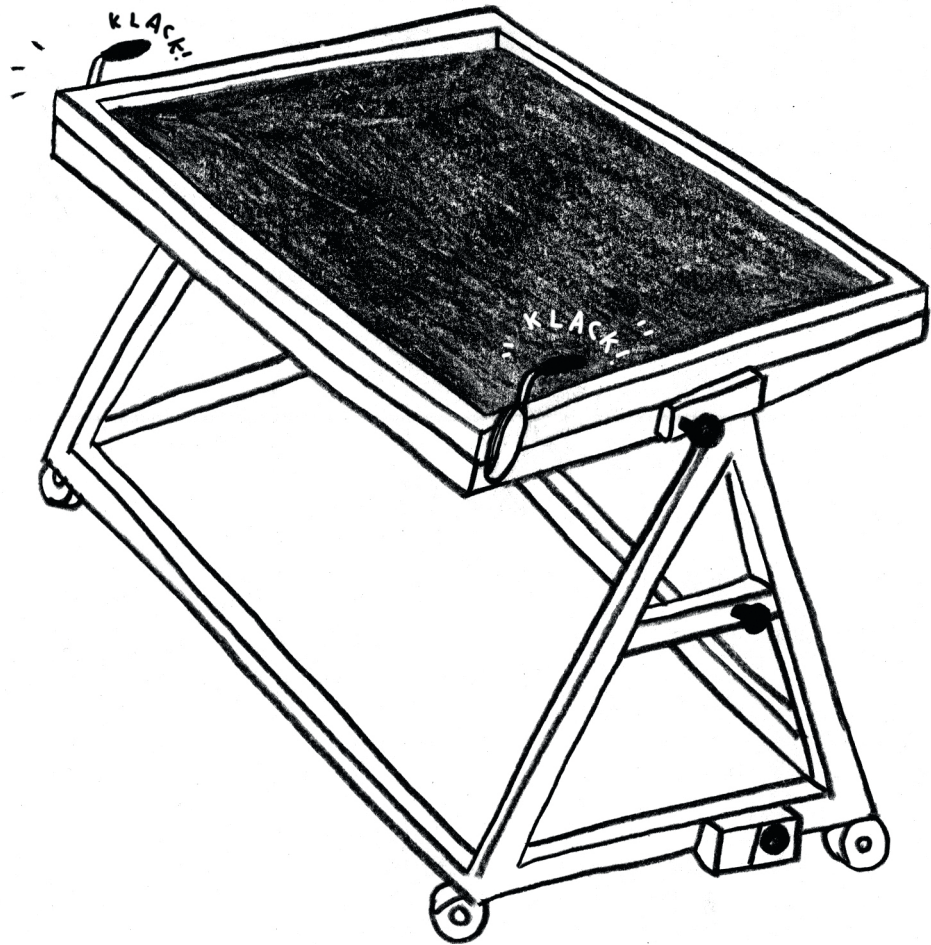

... bis er einrastet!

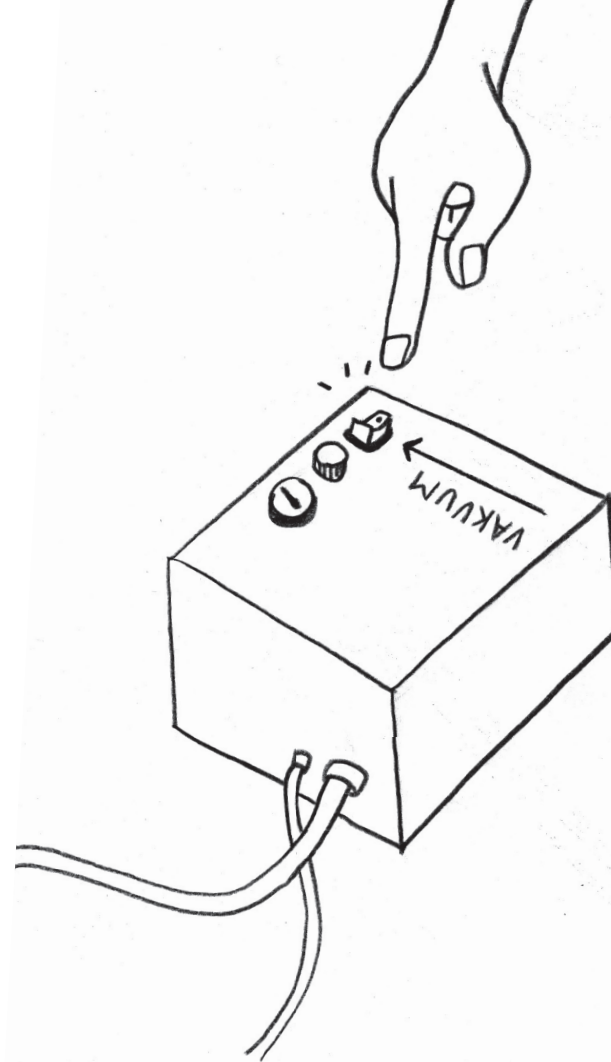

Vakuum einschalten,
warten



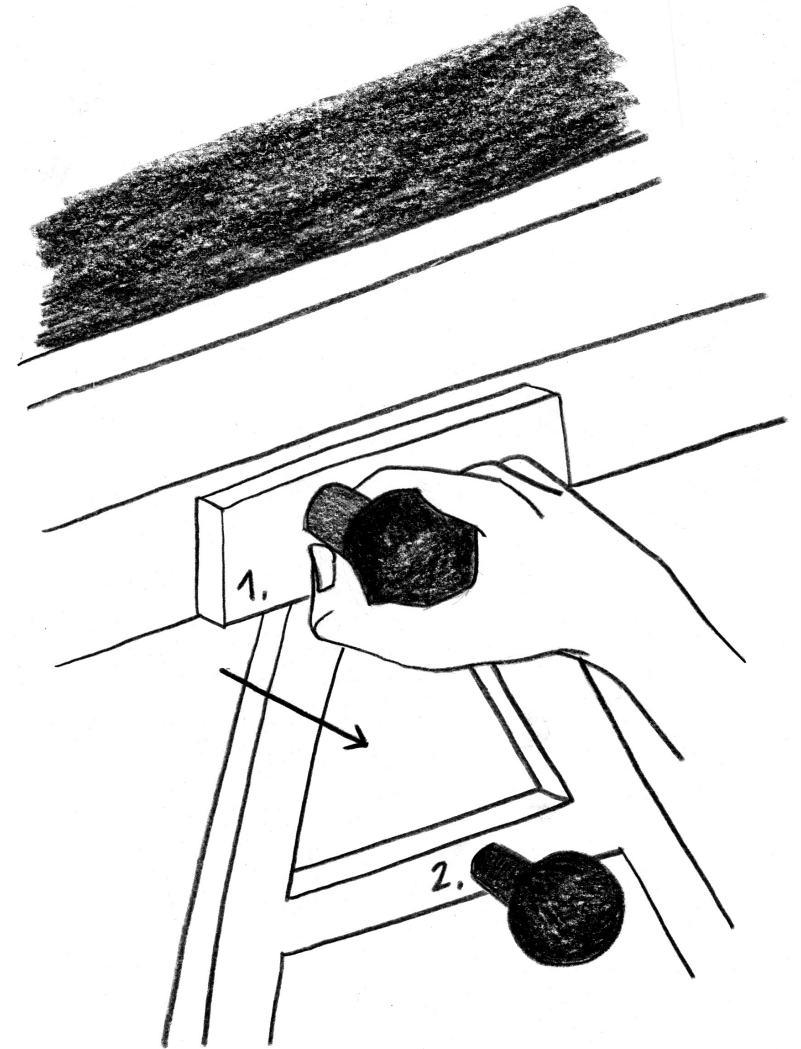
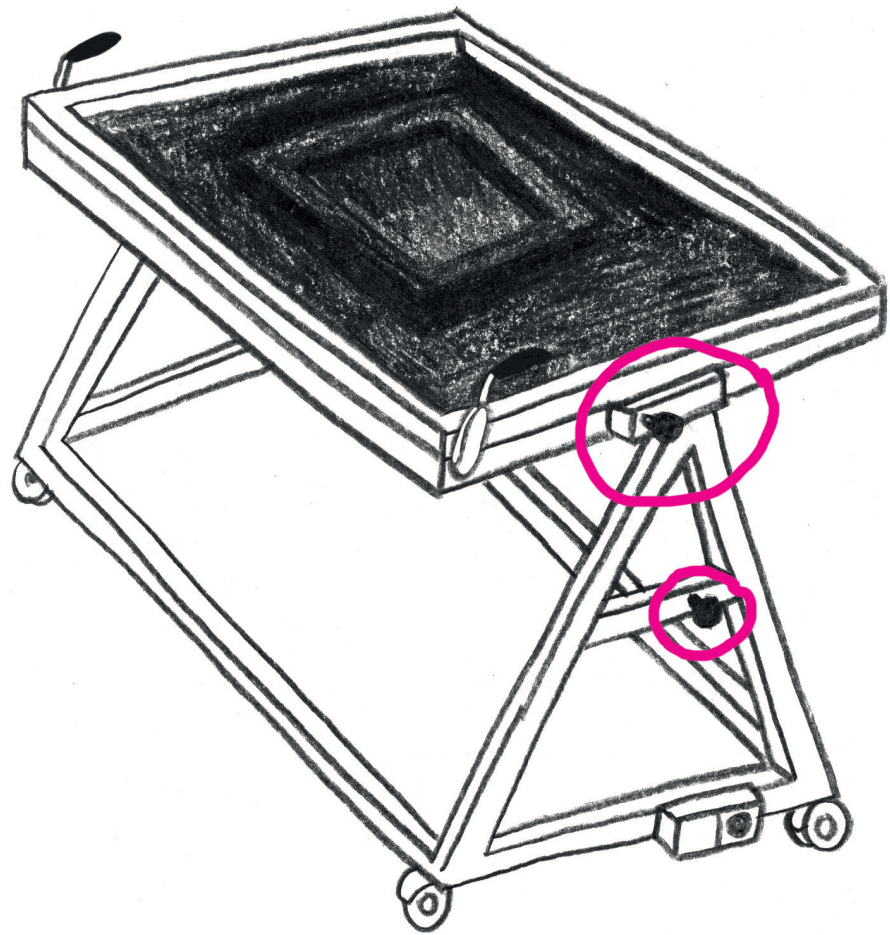

Tisch kippen

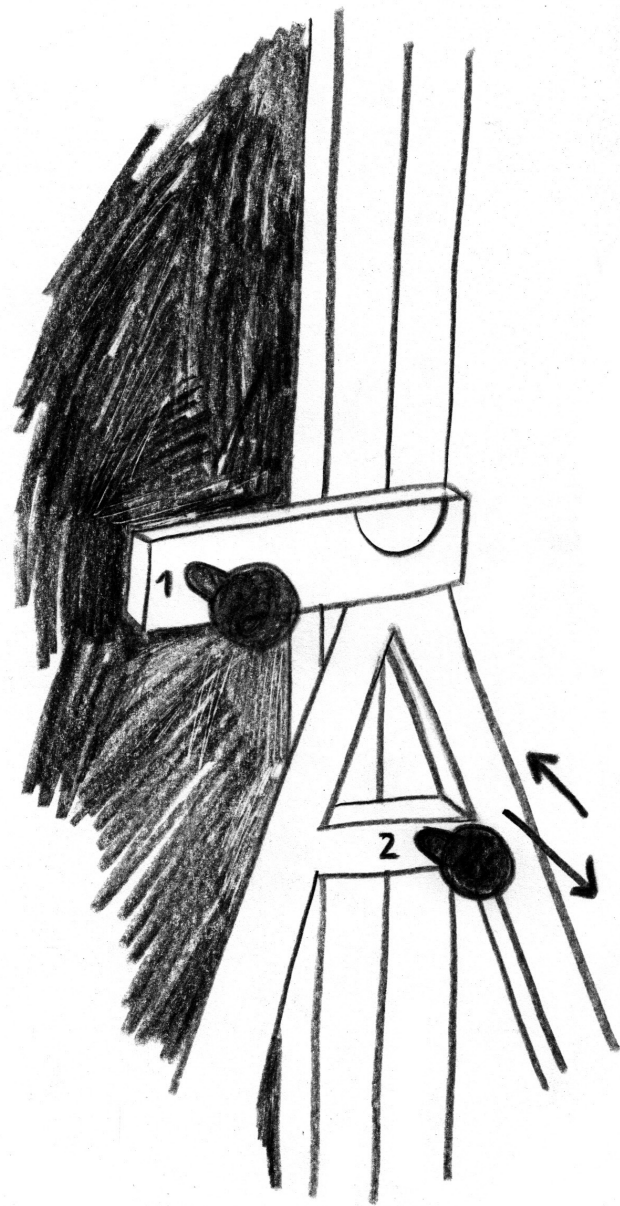

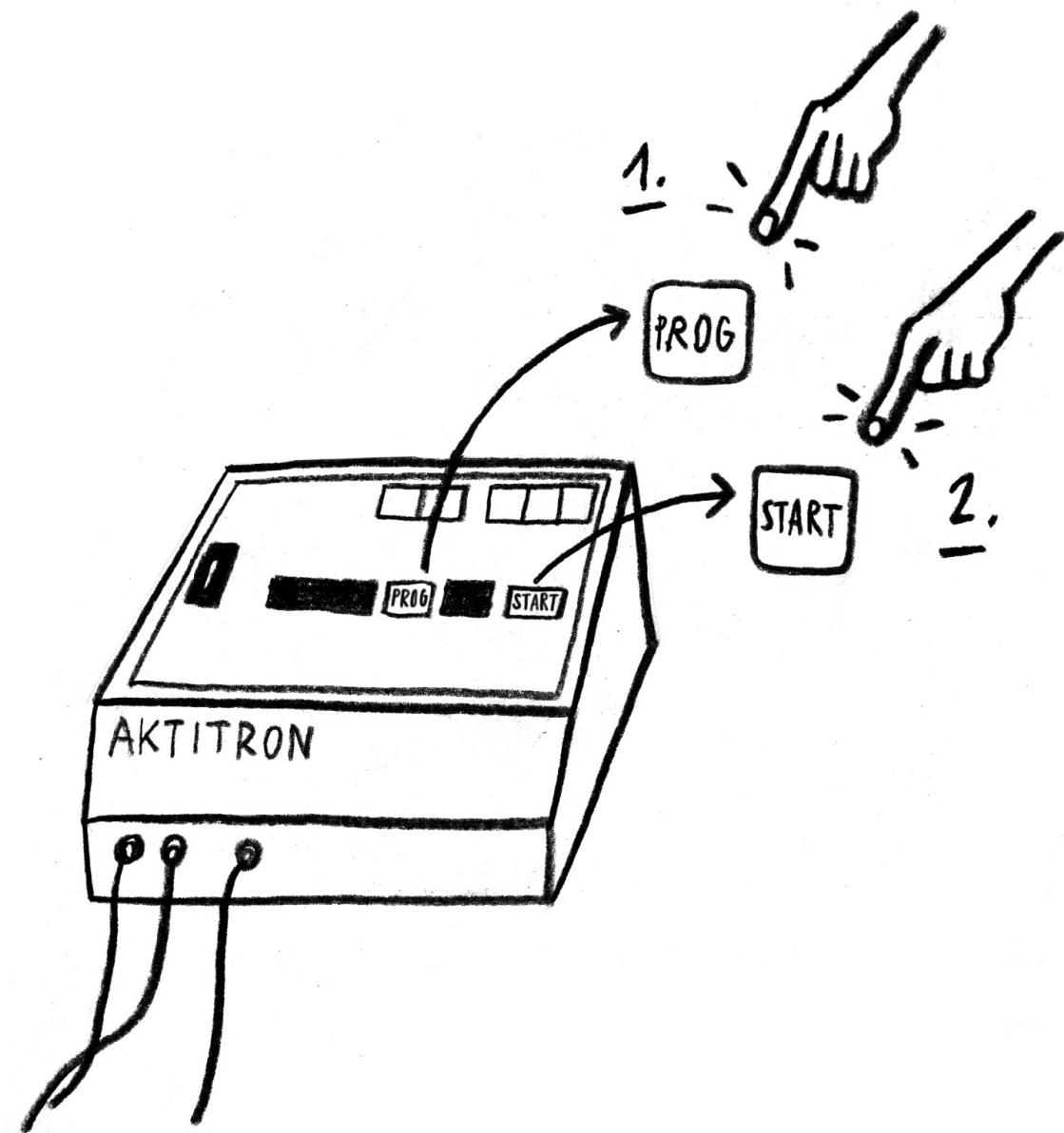

gewünschtes Programm einstellen
(Liste beachten!) – START drücken

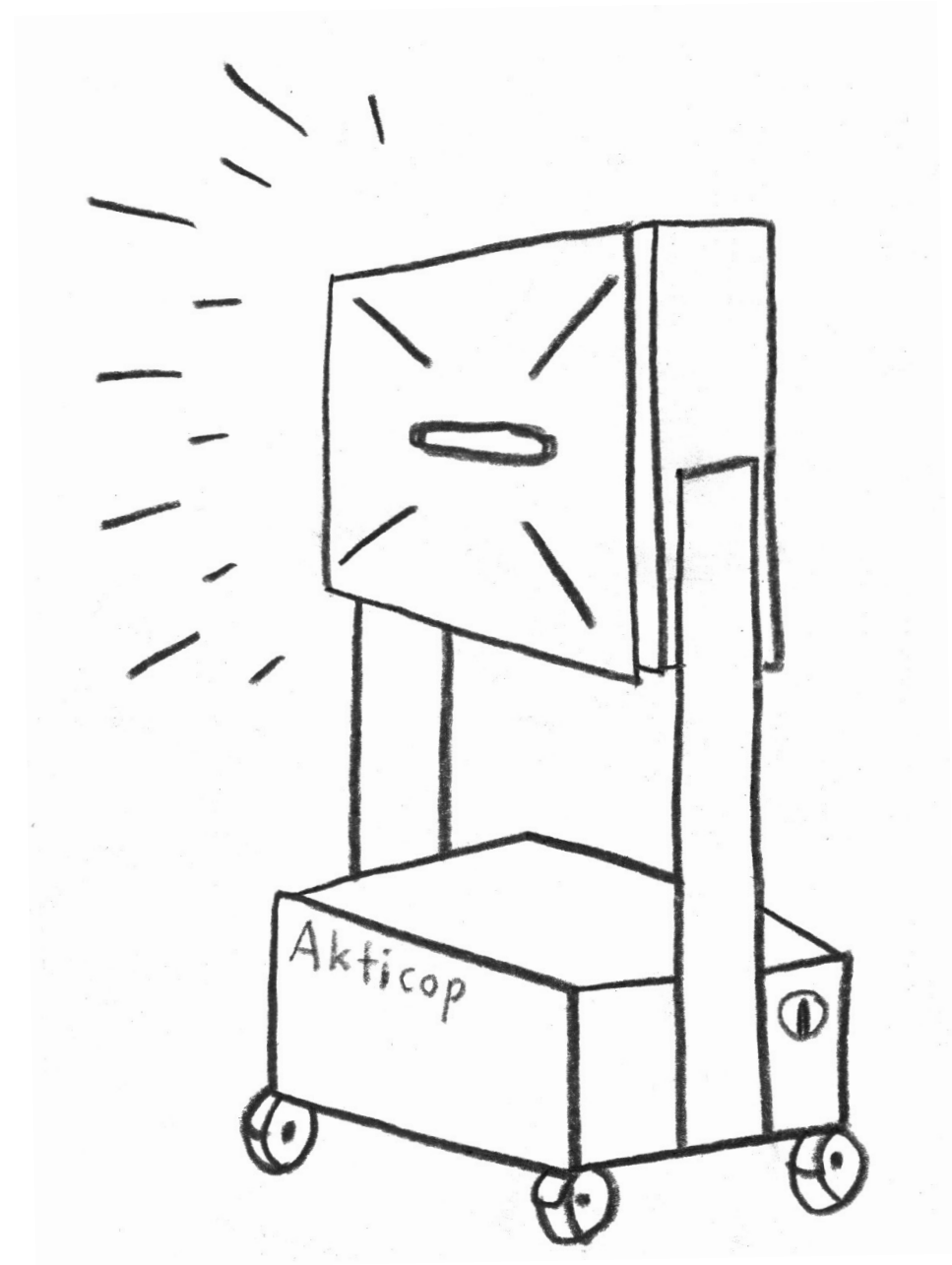

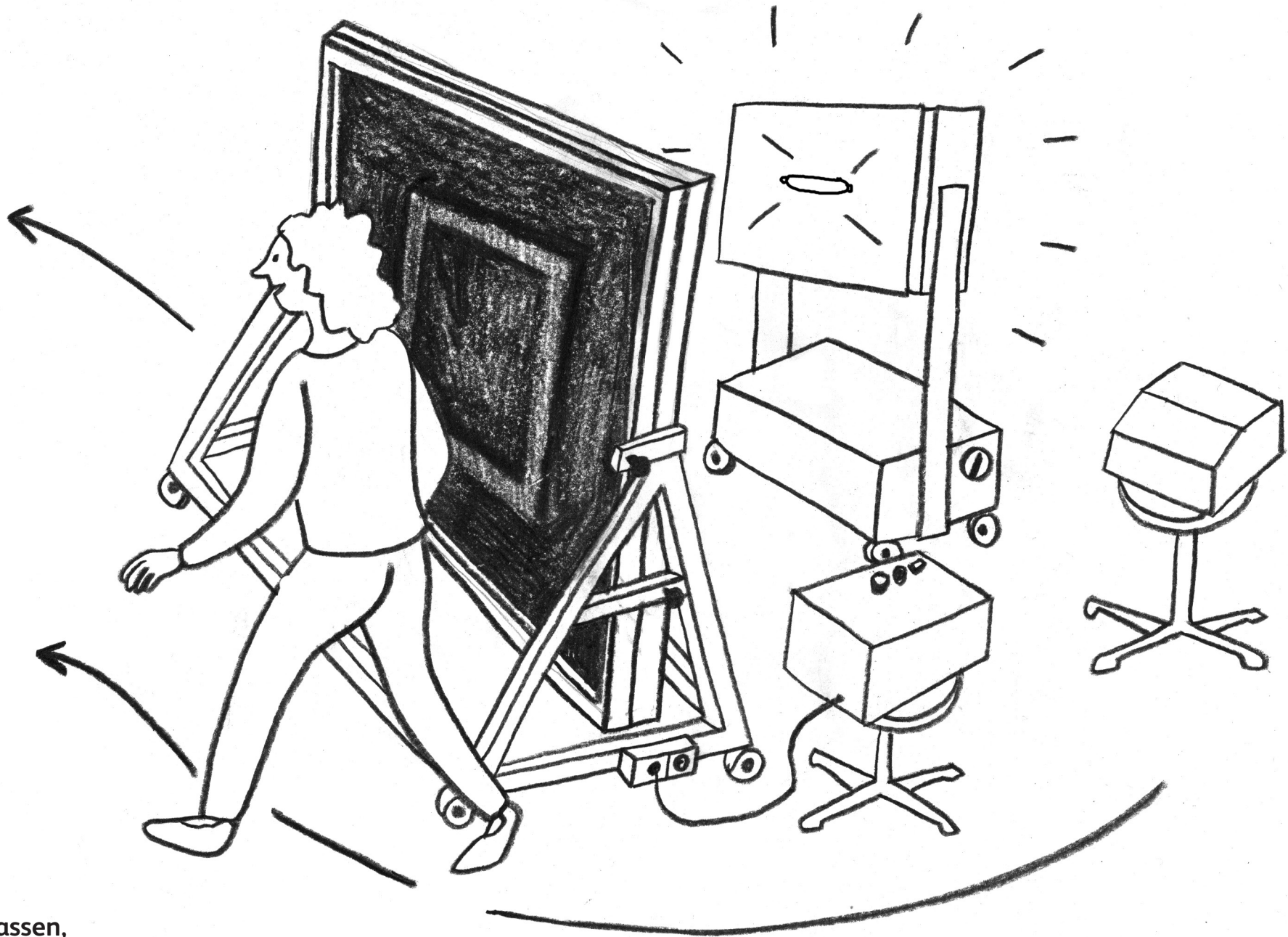

Raum verlassen,
so lange die Lampe brennt